



Atlas Copeo



**PF6 Flex
Control System**

The Future of Flexible Production

Industry Challenges!

Today, customer needs and preferences are changing rapidly and manufacturers need to respond quickly with appropriate products. The cycle of product renewal is becoming shorter and traditional mass production is being challenged, especially with electrification and flexibility.

This is driving manufactures to search more effective ways of developing new technologies and new production lines in the most sustainable way.



Driving Innovation

Atlas Copco's Smart assembly technologies are ready to guide you through this new revolution, from the development phase to production. Overcome your production challenges with some of the most innovative systems on the market



Reduce engineering effort



Accelerate new product introduction and re-balancing



Improve data analytics



Reduce troubleshooting and maintenance time



Eliminate line stops



Reduce intensive training time



Decrease inventory



Improve overall equipment effectiveness (OEE)

Bring your traditional line into the future

Atlas Copco all-new PF6 Flex Control System is a fixtured controller that enables improved flexibility and higher productivity on the line

Innovation is the key to staying competitive



Smart Connected Assembly supports Industry 4.0 becoming a reality. A reality where technology is easy to use and quickly delivers value.

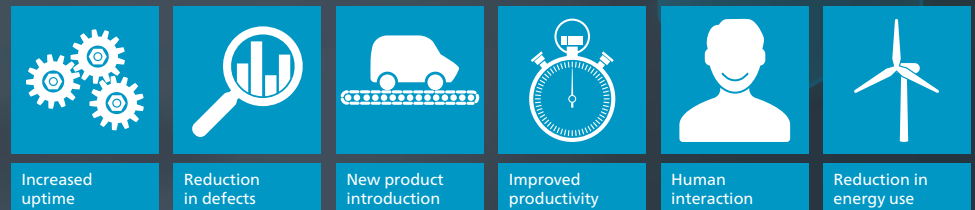

Compact size cuts costs

The new PF6 Flex is designed to optimize the production line. The compact form factor means:

Reduce installation effort with less cables and infrastructure

System integration nearby a connected tool requires no long cables, cable trays, or heavy labor efforts.

Reduce floor utilization and improve your operator and material flow

With its lean design, cleaning up around the workstation becomes a breeze.

Improve freedom on your moving fixtured machines

With its compact size that require less hanging cables, the PF6 Flex become more flexible and lighter, improving ergonomics and work range.

Reduce troubleshooting time and increase OEE

With less components under stress, this modular plug-and-play controller increases your availability by more than 85%.



In conjunction with the most durable fixtured tools on the market today, our Application Centers have the ability to combine standard Atlas Copco accessories to innovate a customized solution, such as a torque arm, wheel multiple, and more.

We can standardize your solution and replicate it in any factory around the world with full Atlas Copco support!

Would you like to learn more about PF6 Flex Control System?



What the customer are saying:

"When I implemented the PF6 Flex, I was able to extend the working range by another 5 meters! I have a ton of freedom on the line and no longer have to worry about cable management and troubleshooting."

Flexibility can reduce your cost and increase your uptime



Increased uptime

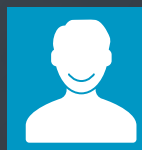

Human interaction



New product introduction

Easy system integration

A modular PF6 Flex reduce your engineering efforts, making the integration with line equipments easier and effective.

Improve your safety, while eliminate multiple cables and increase reliability and Mean Time Between Failures, MTBF without worry about dirt or wet environments.



Cable length
-85%



Installation time
-50%



Floor Space
-95%

What happens if an assembly step fails and the product needs rework?

The PF6 Flex, together with our Scalable Quality Solution (SQS) or Smart AMS software systems, offers the change to create your own state-of-the-art error-proofing system.



Zero defect = no rework, no scrap, no warranty claims, no recalls

Being in control of your processes has never been so easy!!

Improve your processes with the Flex and SQS or Smart AMS!

Result data collection

Operator guidance

Part verification



Reduction in defects



Human interaction



Improved productivity

What the customer are saying:

"I saved two whole installation days using the PF6 Flex. The product is extremely fast and smooth. I also saved seven seconds in cycle times."

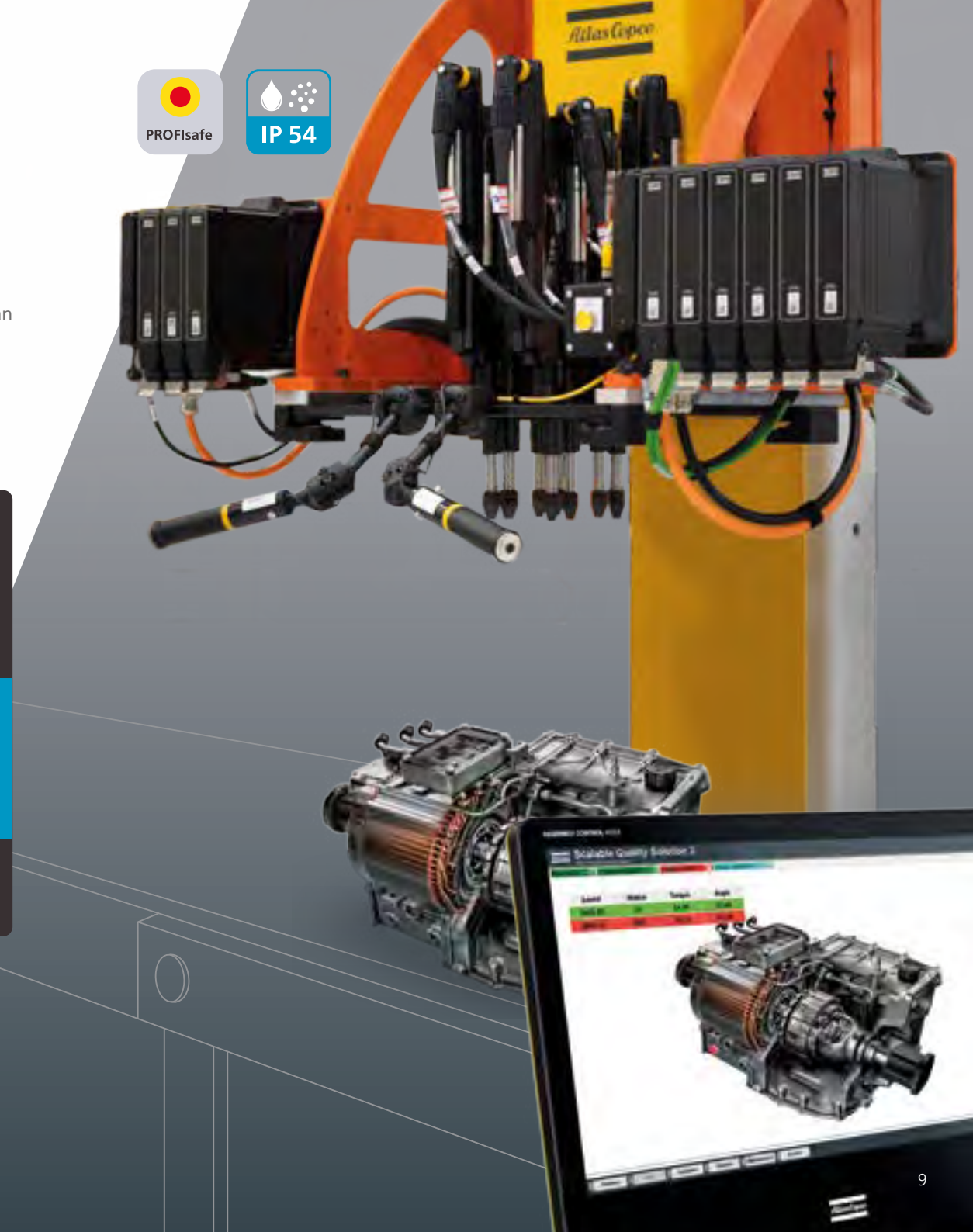

High productivity with high flexibility

How can you increase flexibility without decreasing productivity?

New technologies are coming and production lines need to adapt fast to be able to provide cost-effective solutions. The PF6 Flex is optimized for automation and robotic integration. With its lightweight, modular design and hot swap capabilities, you can reduce the amount of stations on the line, which increases productivity, flexibility as it reduces the total project cost.

This is flexible production... The future is here!

With hotswap capabilities, you can say goodbye to multi-stations that consume production time and floor space.

PF6 Flex flexibility allows hotswap of complete power-heads or different tool configurations keeping the same controller system.

Atlas Copco Service solutions are designed to help you get the most out of your industrial equipment and software systems.. We combine analyses of production data with know-how and expertise in order to enhance your productivity and quality; while keeping your cost efficiency maintenance under control

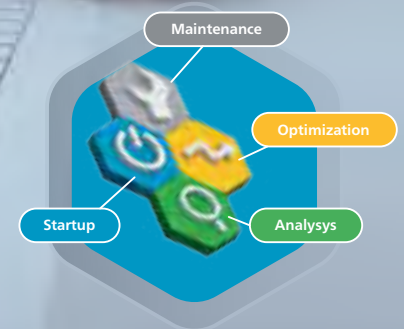

Reduction in defects	Human interaction	Increased uptime

What the customer are saying:

"The PF6 Flex hot swap capability significantly increases flexibility in my plant, reducing line space and saving \$1.2M on my project!"

Do you want to know more about our Fixtured Assembly Solutions?





Are you ready for Industry 4.0?

Industry 4.0 goes further than simply connecting equipment and collecting data. The key factor is the ability to generate useful values out of your data lake.

The ToolsNet 8 user interface can be customized to support different departments and demands, significantly improving quality and efficiency on the line.

MOVE FROM REACTIVE TO PROACTIVE WITH TOOLSNET 8

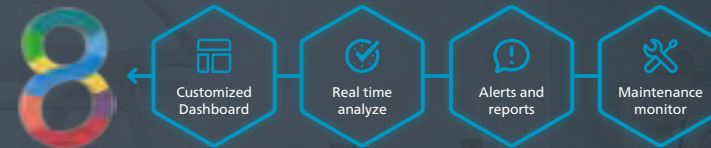

COMMON SOFTWARE PLATFORM TOOLSTALK 2

Take advantage of our simple, intuitive platform, ToolsTalk 2 which saves on training time, along with programming and analysis efforts. The PF6 Flex shares a common interface with Atlas Copco Power Focus 6000, the Power Focus 8, and our Tensor IxB Integrated controller tools!

PF6 Flex is designed with state of the art components for fully automated and robotic applications. It can endure high vibrations and accelerations up to 35Gs.

Our Automation Innovation Center is ready to design fully integrated powerhead systems, including tightening, vision and engineering.

What the customer are saying:

"Atlas Copco full solution made my life easy! We reduced more than 50% our rework and scrap rates with the live dashboard where I am able to verify the quality of my production line in real-time."



Reduction in defects



Reduction in energy use



Improved productivity

PF6 Flex

Flex components



FlexCarrier

- AC-power, with fuse and distribution
- DC 24V power generation
- Emergency stop functions
- Supervision and fan control
- Supports flexible mounting

FlexController IP54

- USB 2.0
- Ethernet communication
- Communication with Fieldbus module
- PROFIsafe capability
- Real-time Clock (RTC) with backup (10 years)
- Fully isolated, external IO ports
- ProfiNet Controller
- FlexIAM (Intelligent Application Module)

FlexDrive

- Power supply for the motor
- Inrush and DC-bus monitoring
- 3-phase power stage and current measurement
- Tool interface driver and tool power supply
- Temperature sensor, power stage and analysis
- Class III emergency stop channel
- AC input-, DC bus- and Current-control
- Tool control
- Servo
- Power rectification
- Control board
- Tool cable port to spindle.

PF6 Flex Components

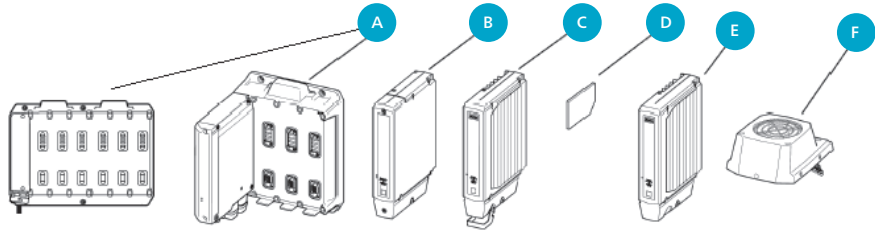

Power cables

Power cable, right entry (RE)

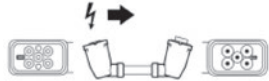

Right entry (RE) power cables are used when the FlexCarriers are mounted horizontally.

Length	Name	Article number	Description
0.22 m	Power Cable	4222 1946 11	PF6 Flex RE 0.22m
0.365 m	Power Cable	4222 1946 12	PF6 Flex RE 0.365m

Power cable, left entry (LE)

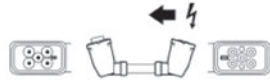

Left entry (LE) power cables are used when the FlexCarriers are mounted horizontally.

Length	Name	Article number	Description
0.22 m	Power Cable	4222 2082 11	PF6 Flex LE 0.22m
0.365 m	Power Cable	4222 2082 12	PF6 Flex LE 0.365m

Power cable, straight to right entry (SRE)



Use straight to entry (SRE) power cables when the FlexCarriers are mounted vertically top-down, that is, the first FlexCarrier mounted above second the FlexCarrier.

Length	Name	Article number	Description
0.65 m	Power Cable	4222 2083 11	PF6 Flex SRE 0.65 m

Power cable, right entry to straight (RES)



Use straight to entry (RES) power cables when the FlexCarriers are mounted vertically bottom up, that is, the first FlexCarrier mounted below second the FlexCarrier.

Length	Name	Article number	Description
0.65 m	Power Cable	4222 2084 11	PF6 Flex RES 0.65 m

Control cable



Length (L)	Name	Article number	Description
440 mm	Control Cable	4222 2062 01	PF6 Flex 440 mm
590 mm	Control Cable	4222 2062 04	PF6 Flex 590 mm
820 mm	Control Cable	4222 2062 03	PF6 Flex 820 mm
1 m	Control Cable	4222 2062 11	PF6 Flex 1 m
2 m	Control Cable	4222 2062 12	PF6 Flex 2 m
3 m	Control Cable	4222 2062 13	PF6 Flex 3 m
5 m	Control Cable	4222 2062 15	PF6 Flex 5 m
10 m	Control Cable	4222 2062 20	PF6 Flex 10 m

FlexTool cable



Length	Name	Article number	Description
1 m	FlexTool Cable	4220 5272 01	PF6 Flex-QST 1 m
1.25 m	FlexTool Cable	4220 5272 11	PF6 Flex-QST 1.25 m
1.5 m	FlexTool Cable	4220 5272 12	PF6 Flex-QST 1.5 m
2 m	FlexTool Cable	4220 5272 02	PF6 Flex-QST 2 m
3 m	FlexTool Cable	4220 5272 03	PF6 Flex-QST 3 m
5 m	FlexTool Cable	4220 5272 05	PF6 Flex-QST 5 m
7 m	FlexTool Cable	4220 5272 07	PF6 Flex-QST 7 m
10 m	FlexTool Cable	4220 5272 10	PF6 Flex-QST 10 m
15 m	FlexTool Cable	4220 5272 15	PF6 Flex-QST 15 m

A	FlexCarrier 3 slot	8436 1500 03
A	FlexCarrier 6 slot	8436 1500 06
B	FlexController Anybus	8436 1500 10
B	FlexController ProFiSafe	8436 1500 01
B	FlexController CIPSAFETY	8436 1500 11
C	FlexDrive	8436 1500 02
D	FlexIAM Generic	8436 1500 21
E	FlexBlank	8436 1500 07
F	FlexFan	8436 1500 04

Name	Article number
AnyBus CC - Profibus DPV1	8436 0940 05
AnyBus CC - DeviceNet	8436 0940 10
AnyBus CC - Ethernet/IP 2 PORT	8436 0940 15
AnyBus CC - Profinet IO 2 PORT	8436 0940 20
AnyBus CC - CC LINK	8436 0940 25
AnyBus CC - CC LINK IE	8436 0940 30

Power cable, straight entry (SE)

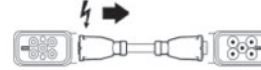

Length	Name	Article number	Description
1 m	Power Cable	4222 1948 01	PF6 Flex SE 1 m
2 m	Power Cable	4222 1948 02	PF6 Flex SE 2 m
3 m	Power Cable	4222 1948 03	PF6 Flex SE 3 m
5 m	Power Cable	4222 1948 05	PF6 Flex SE 5 m
10 m	Power Cable	4222 1948 10	PF6 Flex SE 10 m

Power cable, open end (OE)

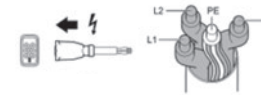

Length	Name	Article number	Description
3 m	Power Cable	4222 1887 03 (EU)	PF6 Flex OE-EU 3 m
		4222 3147 03 (US)	PF6 Flex OE-US 3 m
		4222 3189 03 (orange)	PF6 Flex OE-orange 3 m
10 m	Power Cable	4222 1887 10 (EU)	PF6 Flex OE-EU 10 m
		4222 3147 10 (US)	PF6 Flex OE-US 10 m
		4222 3189 10 (orange)	PF6 Flex OE-orange 10 m
30 m	Power Cable	4222 1887 30 (EU)	PF6 Flex OE-EU 30 m
		4222 3147 30 (US)	PF6 Flex OE-US 30 m
		4222 3189 30 (orange)	PF6 Flex OE-orange 30 m

Do you want to know more about QST fixtured spindles?



QST tool cable



The QST tool cable can be used to extend the PF6 FlexTool cable from the tool to the FlexDrive.

Length	Denomination	Article number	Length	Denomination	Article number
2 m	QST tool Cable	4220 3799 02	4.5	QST Robotic Cable	4220 5399 04
3 m	QST tool Cable	4220 3799 03	5	QST Robotic Cable	4220 5399 05
5 m	QST tool Cable	4220 3799 05	5.8	QST Robotic Cable	4220 5399 05
7 m	QST tool Cable	4220 3799 07	7	QST Robotic Cable	4220 5399 70
8 m	QST tool Cable	4220 3799 08	10	QST Robotic Cable	4220 5399 10
10 m	QST tool Cable	4220 3799 10	15	QST Robotic Cable	4220 5399 15

The Atlas Copco logo consists of the brand name in a stylized, italicized serif font, centered between two horizontal white bars.

Atlas Copco Tools Eastern Europe
Elektrárénská 4,
831 04 Bratislava, Slovakia

acta.ee@atlascopco.com
www.atlascopco.com

