

The Atlas Copco logo is displayed in white text on a blue rectangular background. The logo consists of the company name 'Atlas Copco' in a serif font, flanked by two horizontal white bars above and below the text.

On-site industrial gases

Nitrogen & oxygen generators

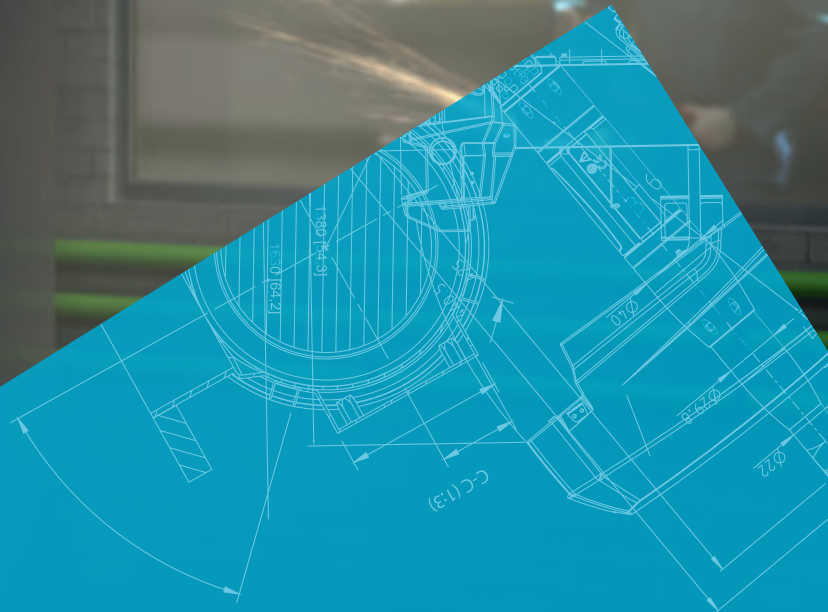

A secure supply of nitrogen and oxygen

Whether your company is specialized in chemical manufacturing, electronics, laser cutting or food and beverage, a dependable supply of industrial gas is crucial. Compared to the on-demand delivery of gas bottles or tanks, on-site production of gas offers a wealth of advantages ranging from cost savings to continuous availability. Atlas Copco's advanced nitrogen and oxygen generators offer you the ultimate solution: flexible on-site production of industrial gas at the lowest possible cost.



On-site vs. liquid or bottled gas

- Your own independent supply of industrial gas.
- Non-stop availability: 24 hours a day, 7 days a week.
- Significant economies of scale and lower operational costs: no rental charges, transport expenses and bulk user evaporation losses.
- No safety hazards when handling high pressure cylinders.
- Easy integration within existing compressed air installations.

Liquid/bottled gas	On-site generation
Lease tank	Capital
N ₂	Energy
Transport	Maintenance
0.1-0.8 EUR/m ³ (*)	0.02-0.15 EUR/m ³ (**)
N ₂ : 99.999%	N ₂ : 95-99.999%

(*) Industry average, other price settings might apply.
 (**) Depending on purity and electricity cost.

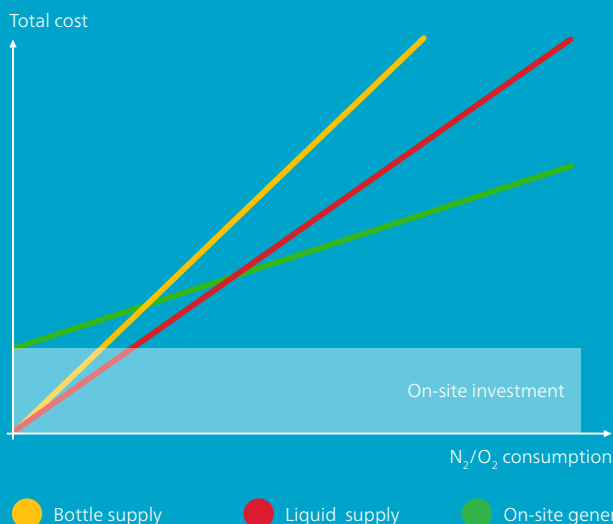

High reliability

- Proven technology: simple, reliable and durable.
- The exact purity your application demands.
- Low operating costs for extra cost-efficiency.
- World-class expertise in a unique market offer from compressed air to gas.

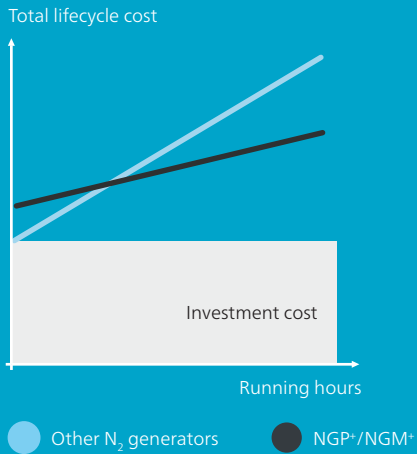

With an air factor* of 1.8 (at 95%) to 5.5 (at 99.999%) and a special cycle time modulation algorithm, the running cost of the new NGP+ can be reduced by 50%, compared to other N₂ generators.

* The air factor is calculated by dividing the inlet air your system needs by the amount of N₂ it produces. The lower the air factor, the more efficient your nitrogen generation.

New generation membrane & PSA generators will change the market

Atlas Copco's latest membrane and PSA generators extend the advantages of the current range. Total lifecycle cost consists of the initial investment cost of the on-site installation, the service cost, and the energy cost. The NGP/NGM range has the lowest investment cost.

However, with increasing running time, you are better advised to switch to the NGP+/NGM+ range to reduce energy costs.



- Energy
- Investment
- Energy savings
- Maintenance

Wide range of applications

- Food & beverage (storage & packaging).
- Chemical applications.
- Pharmaceutical applications.
- Metal heat treatment.
- Plastic injection molding.
- Cable & optical fiber industries.
- Electronics.
- Glass industries.
- Laser cutting.
- Fire prevention.
- Semiconductor manufacturing.
- Aquaculture.

Membrane: Compact all-in-one N₂ supply

Atlas Copco NGM/NGM⁺/NGMs nitrogen generators utilize proprietary membrane separation technology. The membrane separates compressed air into two streams: one is 95-99.9% pure nitrogen, and the other is oxygen enriched with carbon dioxide and other gases.



Instant supply of nitrogen between 95% and 99.9%

The generator separates air into component gases by passing inexpensive compressed air through semi-permeable membranes consisting of bundles of individual hollow fibers.

Each fiber has a perfectly circular cross-section and a uniform bore through its center. Because the fibers are so small, a large amount of fibers can be packed into a limited space, providing an extremely large membrane surface area that can produce a relatively high volume product stream.

Outstandingly dry nitrogen

Compressed air is introduced into the center of the fibers at one end of the module and contacts the membrane as it flows through the fiber bores. Oxygen, water vapor and other trace gases easily permeate the membrane fiber and are discharged through a permeate port while the nitrogen is contained within the membrane and flows through the outlet port. Since water vapor permeates through the membrane as well, the nitrogen gas stream is very dry, with dewpoints as low as -50°C (-58°F).

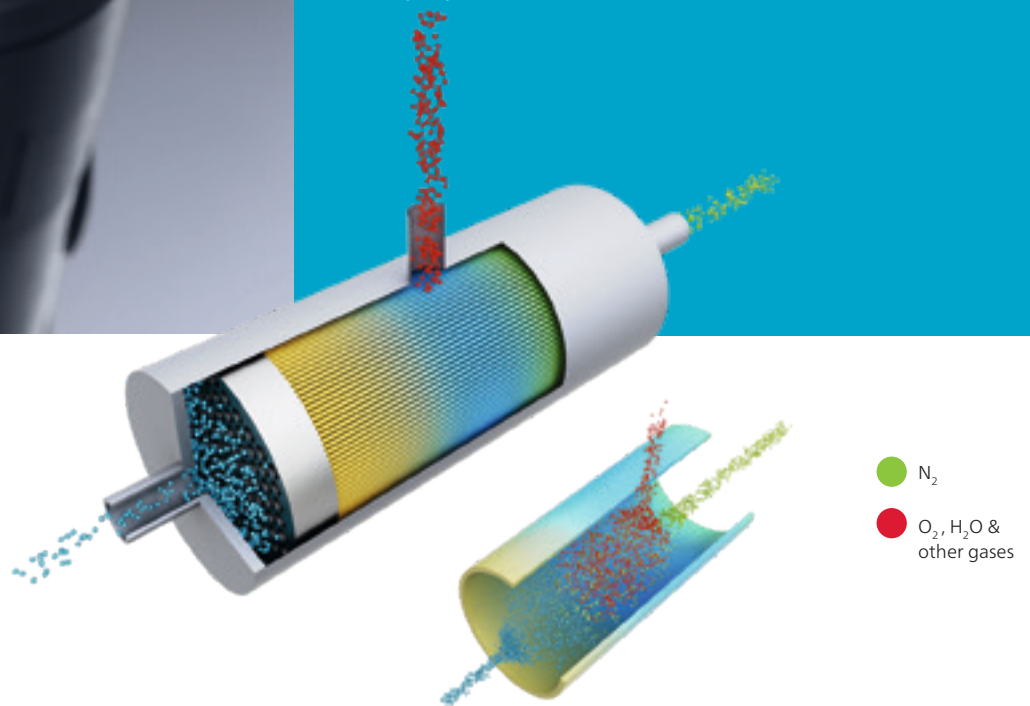

PSA: Reliable and proven

Based on Pressure Swing Adsorption (PSA) technology, Atlas Copco's NGP/NGP+ nitrogen generators and OGP oxygen generators provide a continuous flow of nitrogen and oxygen at desired purity.

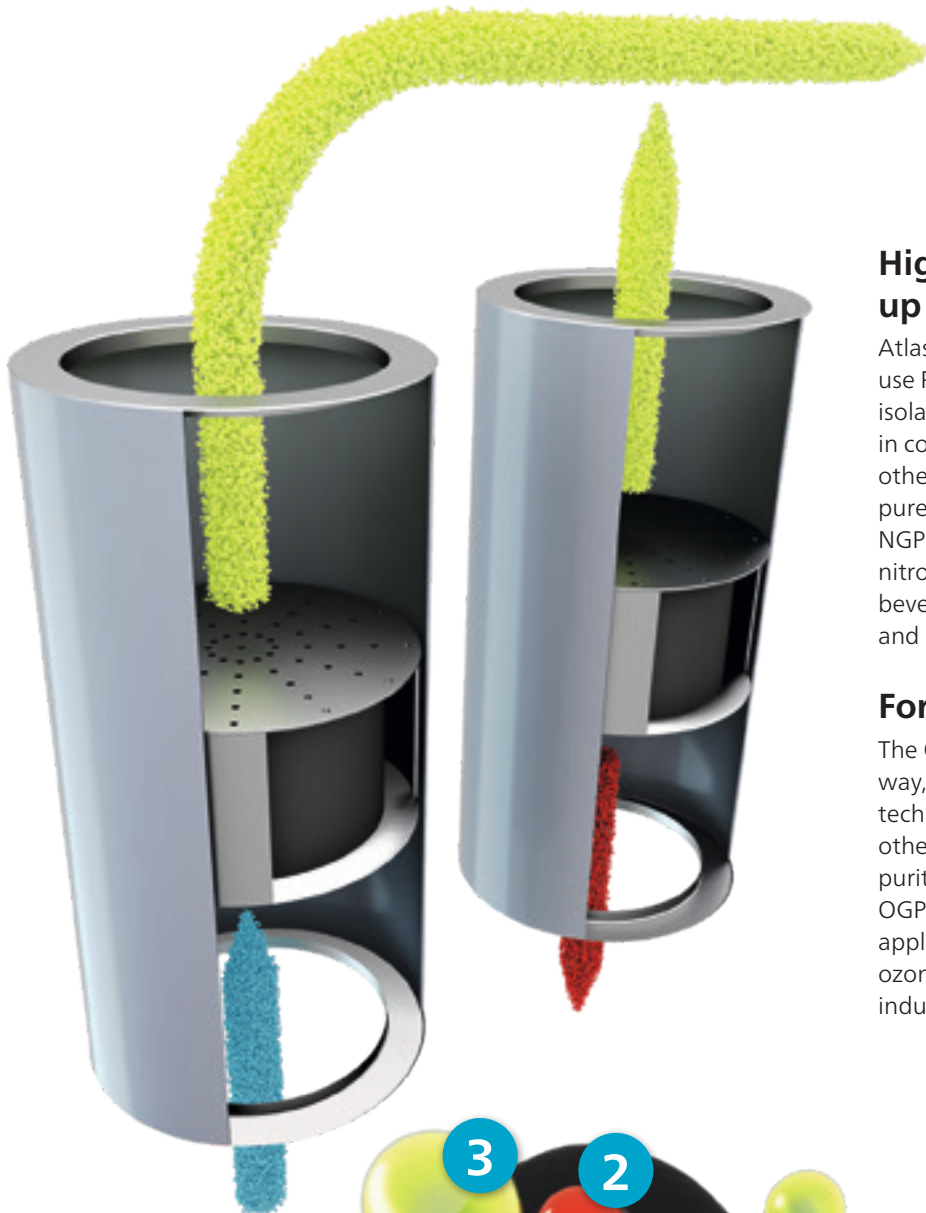







High purity nitrogen supply up to 99.999%

Atlas Copco's NGP/NGP+ nitrogen generators use Pressure Swing Adsorption technology to isolate nitrogen molecules from other molecules in compressed air. Oxygen, CO₂, water vapor and other gases are adsorbed. The result is virtually pure nitrogen at the outlet of the generator. The NGP/NGP+ Series is a very cost-efficient source of nitrogen used in various industries like food and beverage, metal processing, electronics, and many others.

For all your oxygen needs

The OGP oxygen generator works in a similar way, using Pressure Swing Adsorption technology to isolate oxygen molecules from other molecules in compressed air to leave high purity oxygen at the outlet of the generator. The OGP Series provides cost-efficient oxygen for applications such as waste water treatment, ozone production, health care, and the glass industry.



-  Clean and dry compressed air (pressurized)
-  Nitrogen gas (pressurized)
-  Oxygen exhaust (depressurized)
-  Adsorbent
-  1 Adsorbent
-  2 Nitrogen (or oxygen) molecules trapped in the adsorbent
-  3 Oxygen (or nitrogen) molecules passing through

Total solutions from Atlas Copco

With a full range of nitrogen and oxygen generators to choose from, Atlas Copco brings you the right supply of nitrogen and oxygen to meet your specific needs and optimize your production process at the same time.

High quality compressed air

On-site nitrogen and oxygen generation requires the most reliable and efficient compressed air solution. Drawing on our vast experience, Atlas Copco has been leading the industry in compressed air technology for decades.

Typical installation: compressor with integrated dryer, pre-filter UD*, Active Carbon Tower QDT, dust filter, receiver, NGP* nitrogen PSA generator, receiver.

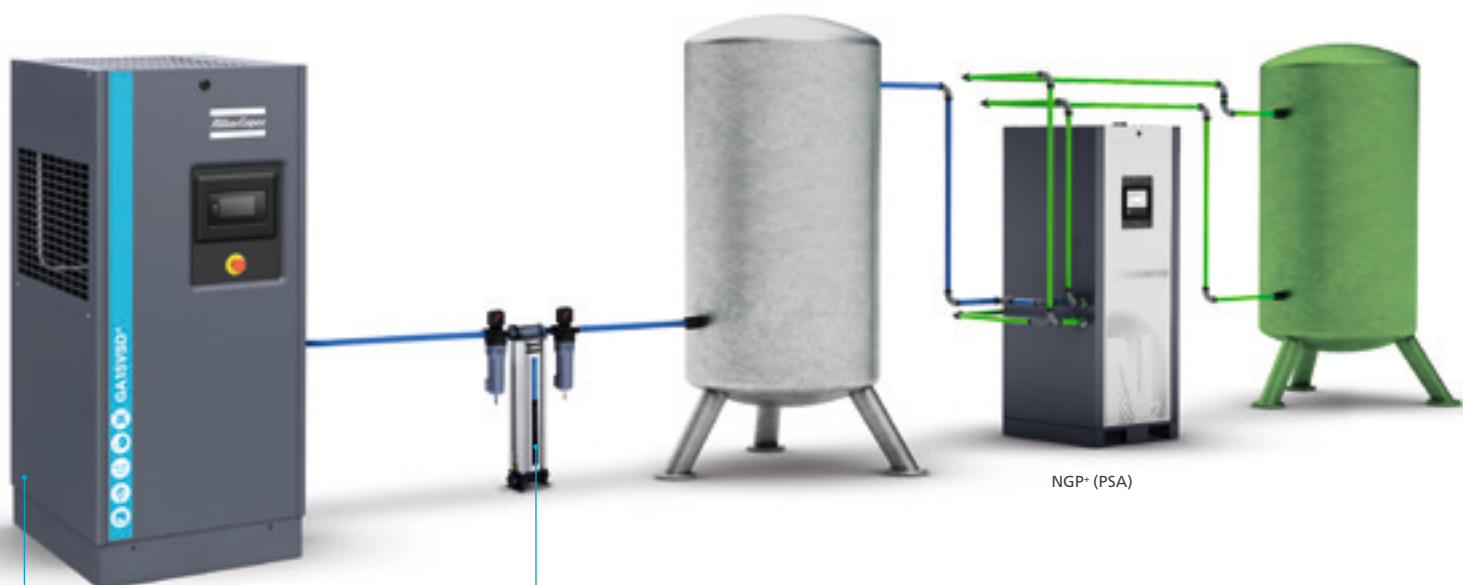

Oil-injected compressors

Integrated onto the production floor, Atlas Copco's oil-injected compressors provide a dependable flow of compressed air directly to the point of use. The GA range even comes with integrated dryer for high quality air. Built to perform in harsh environments, Atlas Copco compressors keep your production running smoothly and reliably: a very economical solution in combination with nitrogen and oxygen generators.

Air treatment

Atlas Copco has developed and improved air compression and drying techniques. Whatever your installation, application or quality requirements, Atlas Copco can offer the right air treatment solution, including dryers (desiccant, refrigerant, membrane) and filters (coalescing, particle, active carbon).

Advanced monitoring, control & connectivity

Do you operate a smart factory or Industry 4.0 production environment? Atlas Copco's nitrogen and oxygen generators will fit right in. Their advanced monitoring, control and connectivity features allow you to optimize performance and efficiency.

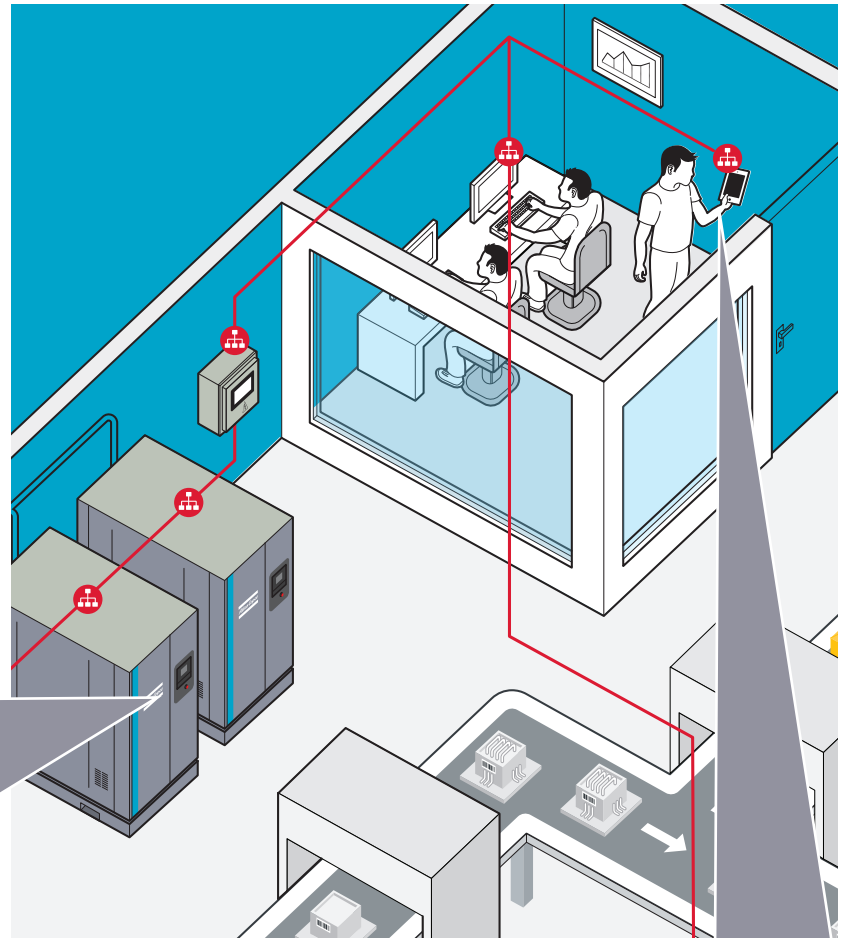

Control

The Elektronikon® operating system gives you numerous control and monitoring options to optimize compressor performance.

Always at your service

Atlas Copco is a truly global organization with support available in more than 160 countries. As a result, one of our 4850 field service engineers is never far away. We pride ourselves on the swift assistance that keeps your Atlas Copco nitrogen and oxygen system performing reliably and efficiently.

Service plan

Our service plans keep your Atlas Copco nitrogen and oxygen system in excellent shape.

Stand-by solutions

Atlas Copco help is available 24/7. We keep spare parts in stock so you are up and running again as quickly as possible.

Rental

Our specialty rental services meet your temporary compressed air needs. With Customer Centers strategically located around the globe, Atlas Copco Rental can provide a solution for virtually any application.

Connect SMARTLINK®: Data Monitoring Program

- Remote monitoring system that helps you optimize your compressed air system and save energy and costs.
- Provides a complete insight in your compressed air network.
- Anticipates potential problems by warning you upfront.

* Please contact your local sales representative for more information.

Membrane nitrogen generators (NGM, NGM+, NGMs)

Based on innovative membrane technology, Atlas Copco's membrane nitrogen generators are flexible enough to adapt to your specific applications. And with low operating costs they offer an excellent return on investment.

Ready to use

- Requires only a supply of dry compressed air.
- No specialist installation or commissioning.
- Fitted with pre-filtration, pressure gauges and flow meter to ensure accurate system monitoring at all times.

Cost savings

- Low operating expenses.
- No additional costs such as order processing, refills and delivery charges.
- Limited maintenance costs.

Exceptional convenience

- Continuous availability (24 hours a day, 7 days a week).
- Risk of production breakdown due to gas running out is eliminated.

Desired purity

- Nitrogen supply according to your need: from 5% to 0.1% oxygen content.
- Very easy to set up the device for other purity levels.

All-in-one

- Fully integrated package.
- Filters and oxygen sensor as standard.

High flow capacity

Ideal for applications such as fire prevention, tire inflation, oil & gas, marine, packaging and many more.

Long lifetime

- No aging.
- No heater.
- Lasting performance.



NGMs: efficiency in low flow nitrogen generation

If you don't need a generator with a high nitrogen flow and purity, the NGMs is your perfect solution. It meets your specific requirements with Atlas Copco quality, high efficiency, little maintenance and zero operational costs.



PSA nitrogen and oxygen generators (NGP, NGP⁺, OGP)

Atlas Copco's NGP, NGP⁺ and OGP nitrogen and oxygen generators are easy to install and use. They offer the required purity with a high flow capacity, making them suitable for a range of applications.

High flow capacity

The wide product range and gas flows exceeding 3,000 Nm³/h (NGP/NGP⁺) make these generators ideal for a variety of demanding applications.



Exceptional reliability

- Robust design.
- Continuous availability (24 hours a day, 7 days a week).
- Potential risk of production breakdown due to gas running out is eliminated.

Ready to use

- Only requires a supply of dry compressed air.
- Plug-and-play.
- No specialist installation or commissioning.
- Fully automated and monitored including oxygen sensor as standard.
- Service-friendly.

Desired purity

- NGP/NGP⁺: nitrogen concentrations from 95% to 99.999%.
- OGP: oxygen concentrations from 90% to 95%.

Cost savings

- Low operating expenses.
- No additional costs such as order processing, refills and delivery charges.
- Limited maintenance costs.

New generation NGP+ nitrogen generators



1 Self-protective monitoring of the feed air quality

- Temperature.
- Pressure.
- Pressure dewpoint.
- Automatic feed air blow-off in case of contamination.



2 Premium energy efficiency

Air factor (air-to-nitrogen ratio) from 1.8 (95% N₂) to 5.5 (99.999% N₂).

3 Automatic start-up

- Minimum pressure valve with bypass nozzle for fast start-up.
- Eliminates risk of overflow and CMS damage.



4 Highest quality CMS

- High density due to packed bed technology.
- Top/bottom equalization.
- Protected by dedicated pressure sensor.



9

The most complete scope of supply

- Nitrogen flow meter as standard.
- Zirconia oxygen sensor with a long lifetime.
- Outlet pressure reducing valve.
- Nitrogen pressure dewpoint sensor available as an option.

8

Self-regulation and stable purity

- Automatically regulates to the requested nitrogen pressure and purity.
- Extremely easy to change purity.
- Off-spec nitrogen flushing.



7

Control and monitoring

- Remote start-stop.
- Modbus, Profibus and Ethernet.
- SMARTLINK.

5

The ultimate energy saver

- Stand-by mode in case no nitrogen is consumed.
- Cycle time modulation algorithm = extended cycle time at low nitrogen demand = reduced air consumption at low nitrogen demand.

6

Back flow pressurization

- In the pressurization phase nitrogen is used instead of air.
- No oxygen contamination of the CMS before adsorption phase starts.

All-in-one high pressure nitrogen skid

The latest addition to Atlas Copco's specially developed equipment is the all-in-one high pressure nitrogen skid, a true alternative for liquid nitrogen or bottles. Combining a small footprint, easy installation, high reliability and supreme energy efficiency, this unique nitrogen skid truly stands out.

Ideal for a fluctuating nitrogen demand

This innovative nitrogen skid lets you store nitrogen at 40 bar for direct use or 300 bar for bottling. This allows you to base your production on your average nitrogen consumption rather than have your maximum capacity available at all times. This saves initial investment cost and drastically reduces your operating costs.

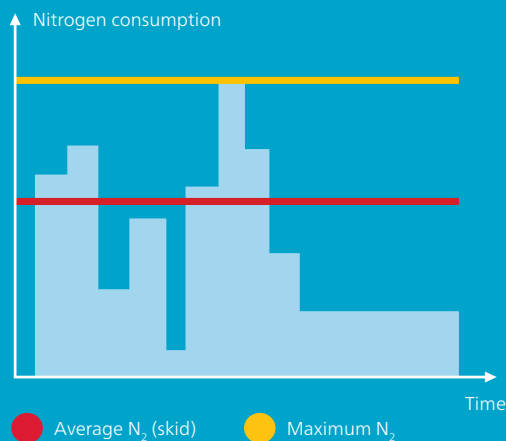

The all-in-one solution

All nitrogen skid components are built to Atlas Copco quality and efficiency standards. They are tested for optimal performance and reliability.

NGP+ nitrogen generator

Nitrogen storage
(40-bar receiver or
300-bar cylinders)

GA VSD+ compressor
reduces energy use
on average 50%

Nitrogen booster
(40 or 300 bar)



Laser cutting

Laser cutting requires a reliable supply of high pressure nitrogen. With its energy efficiency, ease of use and small footprint, the Atlas Copco 300-bar nitrogen skid is the ideal solution.

Technical specifications NGM series

TYPE	Nitrogen purity				Dimensions (W x D x H)		Weight	
		95%	96%	97%	mm	in	kg	lbs
NGMs 1	FND Nm ³ /h	4.6	3.9	3.2	560 x 285 x 1150	22 x 11 x 45	56	123
	FND scfm	2.75	2.3	1.9				
	SCFH	165	140	115				
	Air factor	2	2.2	2.4				
NGMs 2	FND Nm ³ /h	9.6	7.9	6.5	560 x 285 x 1150	22 x 11 x 45	59	130
	FND scfm	5.7	4.7	3.9				
	SCFH	345	284	233.5				
	Air factor	2	2.2	2.4				
NGMs 3	FND Nm ³ /h	14	11.8	9.7	560 x 285 x 1150	22 x 11 x 45	62	136
	FND scfm	8.4	7.1	5.8				
	SCFH	503	424	348				
	Air factor	2	2.2	2.4				
NGM 1	FND Nm ³ /h	11.9	9.7	7.6	820 x 772 x 2090	32.3 x 30.4 x 82.3	259	571
	FND scfm	6.9	5.7	4.4				
	Air factor	2.6	3	3.5				
NGM 2	FND Nm ³ /h	24.1	19.4	15.1	820 x 772 x 2090	32.3 x 30.4 x 82.3	268	591
	FND scfm	14.1	11.3	8.8				
	Air factor	2.6	3	3.5				
NGM 3	FND Nm ³ /h	42.1	34.6	27.4	820 x 772 x 2090	32.3 x 30.4 x 82.3	285	628
	FND scfm	24.6	20.2	16.0				
	Air factor	2.6	3	3.5				
NGM 4	FND Nm ³ /h	83.9	69.5	54.7	820 x 1470 x 2090	32.3 x 57.9 x 82.3	445	981
	FND scfm	48.9	40.5	31.9				
	Air factor	2.6	3	3.5				
NGM 5	FND Nm ³ /h	126.0	104.0	82.1	820 x 1470 x 2090	32.3 x 57.9 x 82.3	497	1096
	FND scfm	73.5	60.7	47.9				
	Air factor	2.6	3	3.5				
NGM 6	FND Nm ³ /h	168.1	138.6	109.1	820 x 1470 x 2090	32.3 x 57.9 x 82.3	535	1179
	FND scfm	98.1	80.9	63.6				
	Air factor	2.6	3	3.5				
NGM 7	FND Nm ³ /h	209.9	173.2	136.4	820 x 1470 x 2090	32.3 x 57.9 x 82.3	571	1259
	FND scfm	122.4	101.0	79.6				
	Air factor	2.6	3	3.5				

Technical specifications NGM⁺ series

TYPE	Nitrogen purity				Dimensions (W x D x H)		Weight	
		95%	97%	99%	mm	in	kg	lbs
NGM 1 ⁺	FND Nm ³ /h	24.3	16.5	8.5	820 x 772 x 2090	32.3 x 30.4 x 82.3	259	571
	FND scfm	14.1	9.6	4.9				
	Air factor	2.2	2.7	4.2				
NGM 2 ⁺	FND Nm ³ /h	48.6	33.0	17.0	820 x 772 x 2090	32.3 x 30.4 x 82.3	268	591
	FND scfm	28.3	19.2	9.9				
	Air factor	2.2	2.7	4.2				
NGM 3 ⁺	FND Nm ³ /h	72.9	49.5	25.5	820 x 772 x 2090	32.3 x 30.4 x 82.3	285	628
	FND scfm	42.4	28.8	14.8				
	Air factor	2.2	2.7	4.2				
NGM 4 ⁺	FND Nm ³ /h	97.2	66.0	34.0	820 x 1470 x 2090	32.3 x 57.9 x 82.3	445	981
	FND scfm	56.5	38.4	19.8				
	Air factor	2.2	2.7	4.2				
NGM 5 ⁺	FND Nm ³ /h	145.8	99.0	51.0	820 x 1470 x 2090	32.3 x 57.9 x 82.3	497	1096
	FND scfm	84.8	57.6	29.7				
	Air factor	2.2	2.7	4.2				
NGM 6 ⁺	FND Nm ³ /h	194.4	132.0	68.0	820 x 1470 x 2090	32.3 x 57.9 x 82.3	535	1179
	FND scfm	113.0	76.7	39.5				
	Air factor	2.2	2.7	4.2				
NGM 7 ⁺	FND Nm ³ /h	243.0	165.0	85.0	820 x 1470 x 2090	32.3 x 57.9 x 82.3	571	1259
	FND scfm	141.3	65.9	49.4				
	Air factor	2.2	2.7	4.2				

FND: Free Nitrogen Delivery

Reference conditions

Compressed air effective inlet pressure: 8 bar(g)/116 psi(g).
 Nitrogen outlet pressure: 6.5 bar(g)/94 psi(g).
 Ambient air temperature: 20°C/68°F.
 Pressure dewpoint inlet air: 3°C/37°F.
 Pressure dewpoint nitrogen: -50°C/-58°F.
 Minimum refrigerant dryer required to precondition inlet air.
 Typical nitrogen quality 1.2.1 according to ISO 8573-1:2010.

Operating limits

Minimum ambient temperature: 5°C/41°F.
 Maximum ambient temperature: 50°C/122°F.
 Maximum compressed inlet air pressure 13 bar(g)/189 psi(g).

NGMs performance

is based on 20°C/7 bar at membrane (1000Mbar) +/-5%.

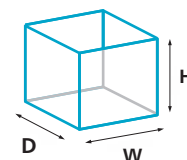



Atlas Copco

www.atlascopco.com

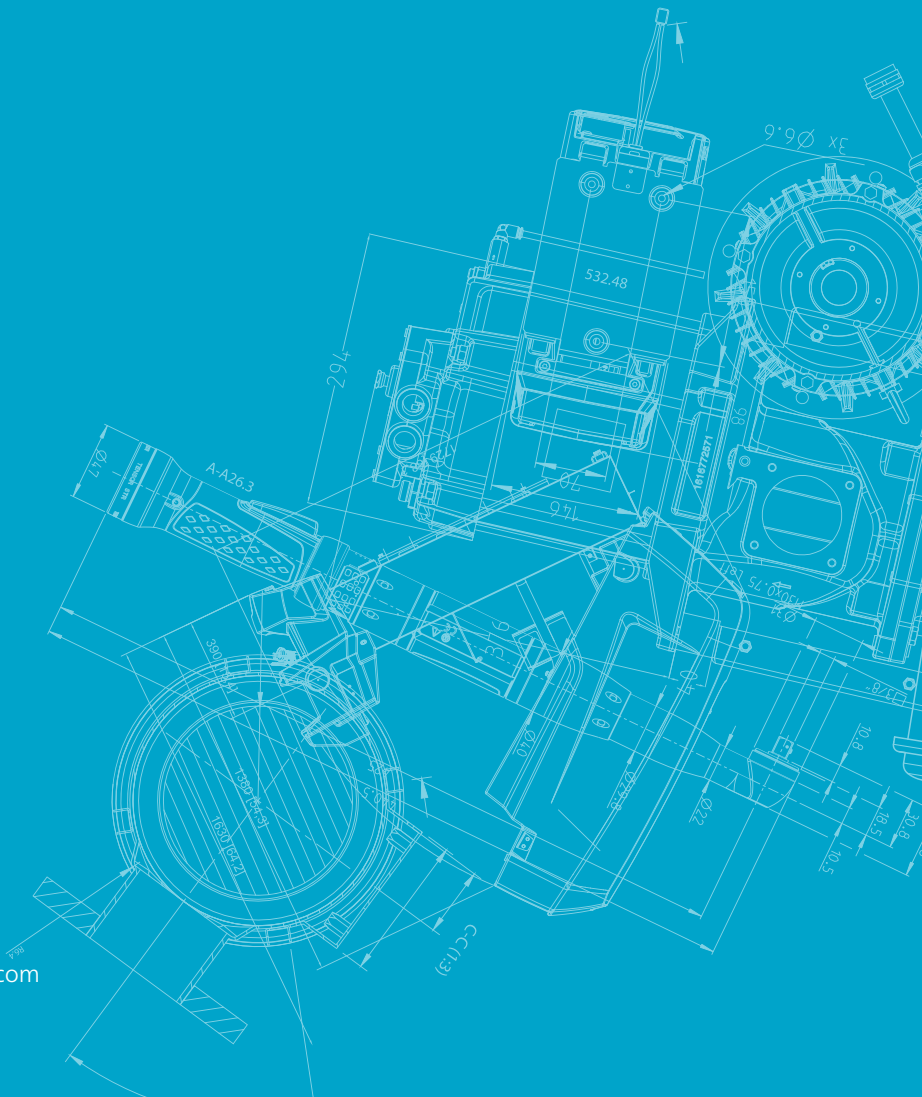

2935 0977 45 © 2019 Atlas Copco Airpower NV, Belgium. All rights reserved. Designs and specifications are subject to change without notice or obligation. Read all safety instructions in the manual before usage.