

# Slurry pumps WEDA L

The WEDA slurry pumps are the toughest, and have the largest apertures to facilitate handling of slurry with the most challenging solids.

## EFFICIENT MOTOR

Electric motor insulation class H with PTC and Clicson thermal protection and service factor S1

## ROBUST DESIGN

Heavy duty bearings to withstand shocks and overloads

## REINFORCED SEALING

A double silicon carbide mechanical seal for duty application

## SUSTAINABLE PERFORMANCE

High efficiency high chrome agitator to lift settled solids

## EASY ACCESS

Efficient motor cooling with top discharge and side flow

## HIGH ABRASION RESISTANCE

Thanks to the high-chrome wear parts

## HIGHER SOLIDS HANDLING

Slurry pumps can handle solids up to 2.5 in

**SOLIDS  
HANDLING**  
UP TO **2.5** inch

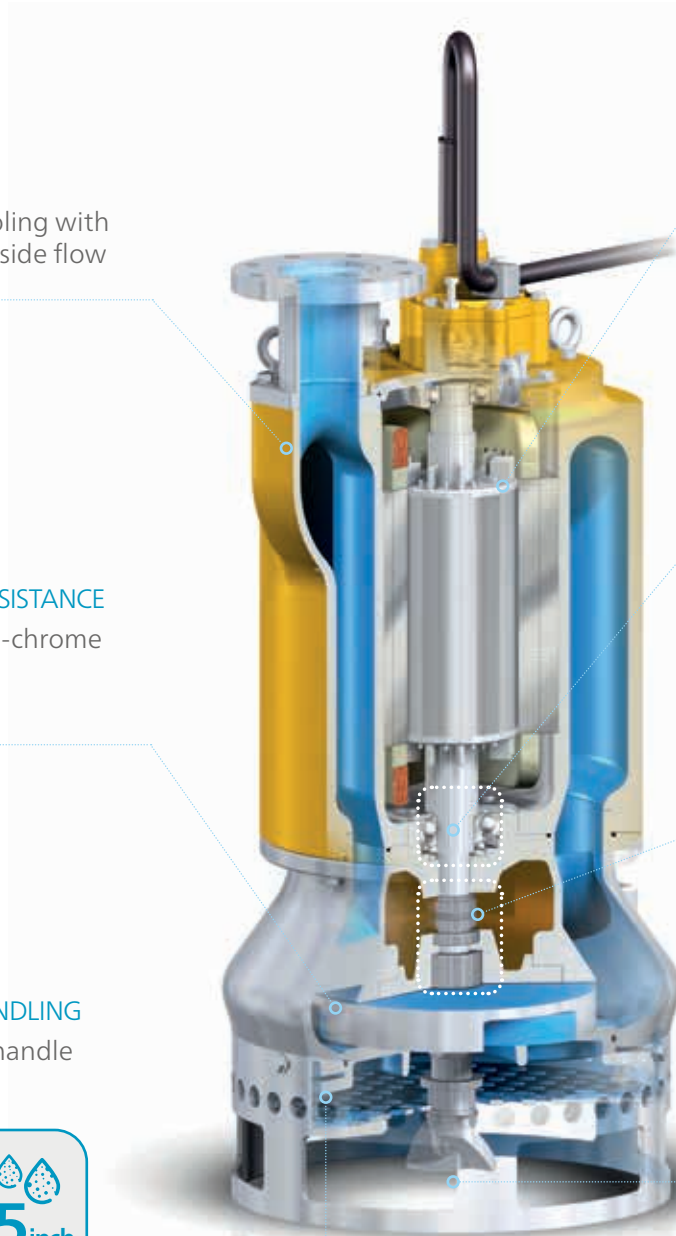

# Slurry pumps, WEDA L

## Technical data



		WEDA L40N	WEDA L50N	WEDA L60N	WEDA L70N	WEDA L80N	WEDA L95N	WEDA L100N	WEDA L110N
Specifications		3ph	3ph	3ph	3ph	3ph	3ph	3ph	3ph
Max. head	ft	47	57	75	85	98	171	108	174
Max. flow	US gpm	247	308	440	616	660	880	1320	2112
	m <sup>3</sup> /hr	57	71	101	142	152	202	304	486
Rated output	hp	5	7	12	15	20	50	60	101
Max. power input	kW	6	9	14	17	22	54	65	107
Discharge connection	in	3" NPT	4" NPT	4" NPT	4" NPT	ASME 4" 150lb	ASME 6" 150lb	ASME 6" 150lb	ASME 6" 150lb
Max solid handling	in	0.8	1.0	1.0	1.0	1.0	1.4	2.4	2.4
Weight and dimensions									
Weight	lbs	408	573	573	595	684	1654	2216	2359
Height	in	31	36	36	36	42	63	63	63
Width	in	15	17	17	17	23	37	37	37
Diameter	in	13	16	16	16	19	21	21	21

## Typical applications

- Abrasive media with high solids content
- Quarries
- Dredging
- Settling ponds

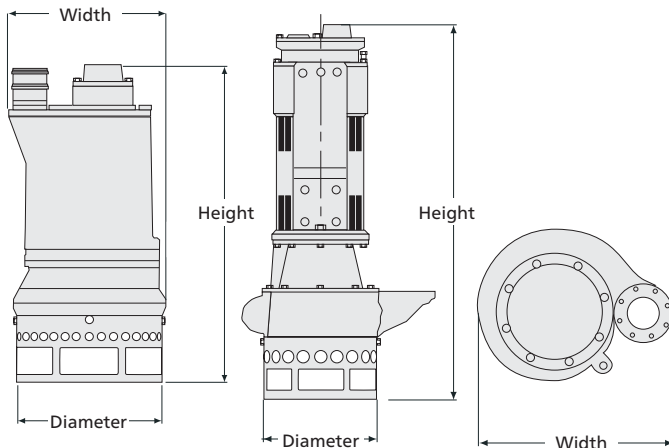

# Performance curves

## WEDA L40N

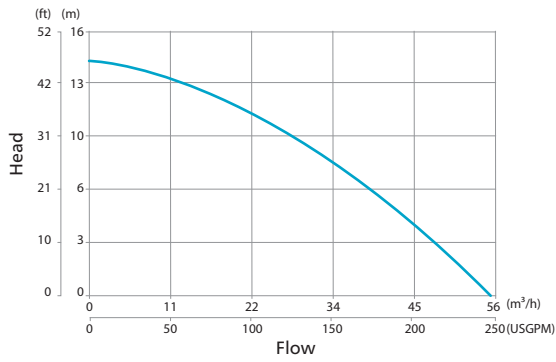

## WEDA L50N

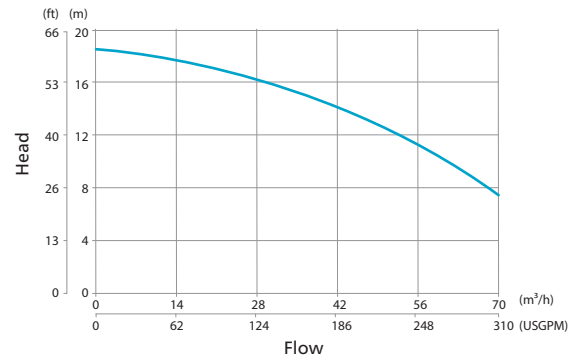

## WEDA L60N

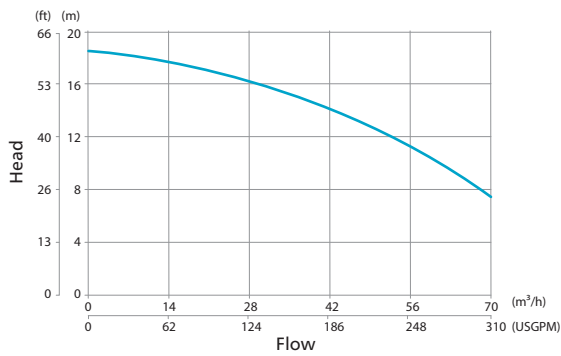

## WEDA L70N

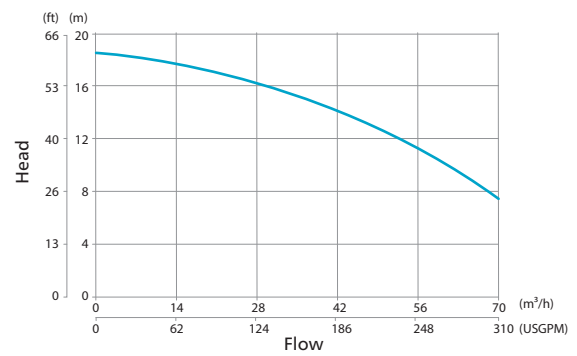

## WEDA L80N

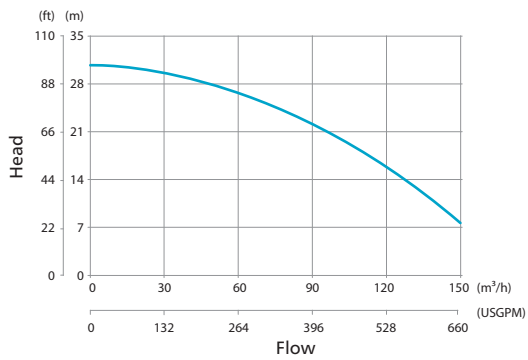

## WEDA L95N

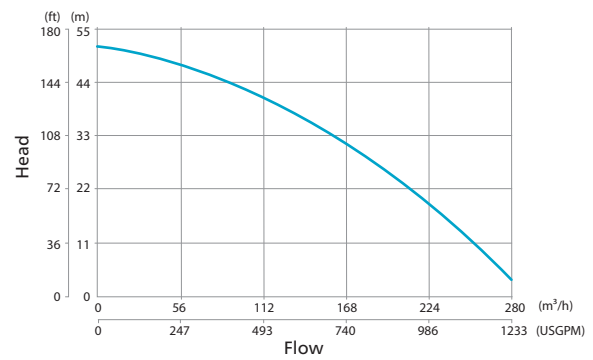

## WEDA L100N

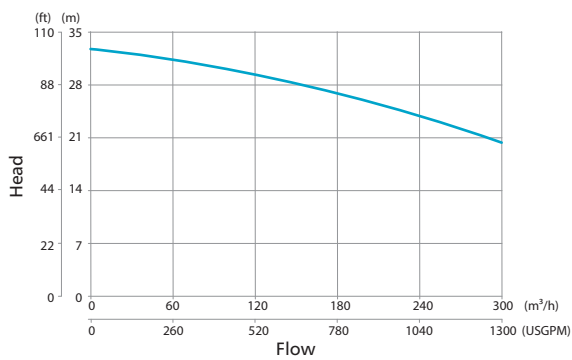

## WEDA L110N

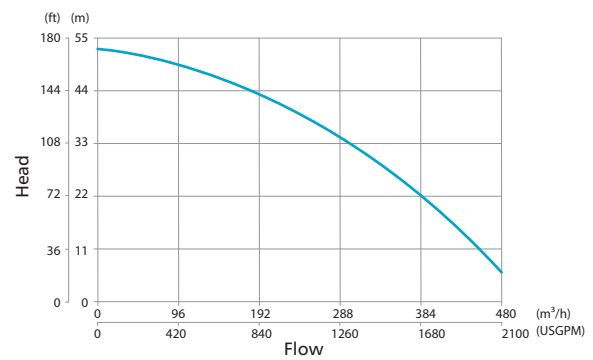

— Normal head

According to ISO 9906 – ANNEX A

# We have all the accessories you need for your WEDA pump

## Control panel

For easy control of pumps, different options available.



## Discharge connections

It can be mounted in either a vertical or horizontal position.



• NPT

## Slim Adapter

For lowering pumps in narrow pipes and manholes D50H, D60H, D70H, D90H only



## Raft

For easy floatation of pump with fluctuating water levels. Strainer option available



## Level regulators

For easy control of water level by automatic pump switch-on/-off:



• Float switch

## Zinc anodes

Specifically required for pumping water with a high concentration of salts such as sea water, brine, etc.



## Low suction collar

To easily drain the water level down to the floor.

## Epoxy coating

For protecting pumps in highly acidic media.

## Service kits

### Seal kit

The seal kit is the proper selection of high quality components for a mechanical seal change to ensure trouble-free operation after servicing.

- O-ring kit
- Mechanical shaft seal



### Instant service pack

The instant service pack is a preassembled, tested and ready-to-use seal system containing the mechanical shaft seals, bearings, gaskets and oil to ensure trouble-free operation. It offers a quick onsite repair option due to ease of installation and therefore reduces the machine downtime cost.



### Wear part kit

The wear part kit is a typical selection of components to bring the pump performance back to factory standard. The ideal solution for a machine overhaul or refurbishment.

- Impeller
- Wear plate
- Diffuser
- Impeller nut