

PART	4027123409	Status	Released	Rev./Iter	1.1
Drawing	4027123409	Status		Rev./Iter	1.1

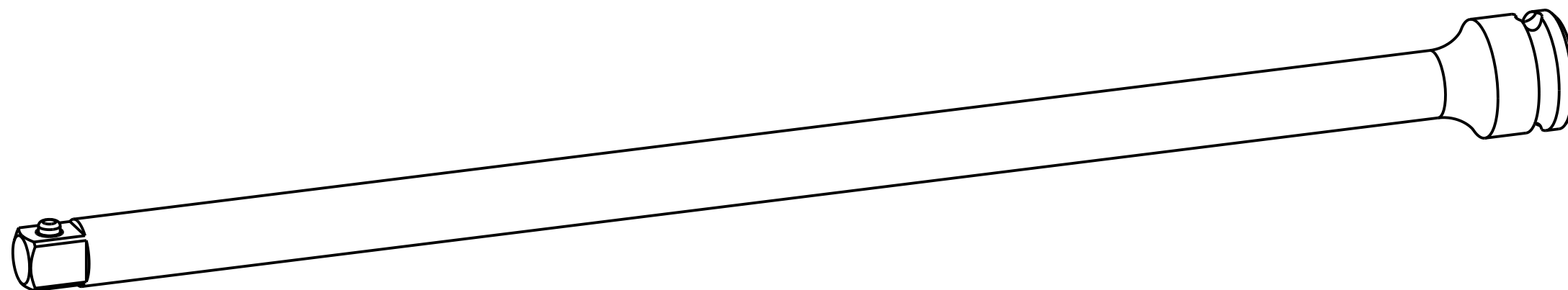
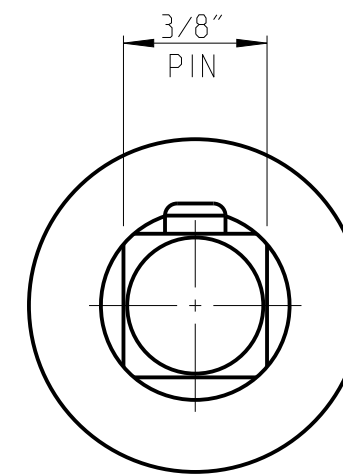
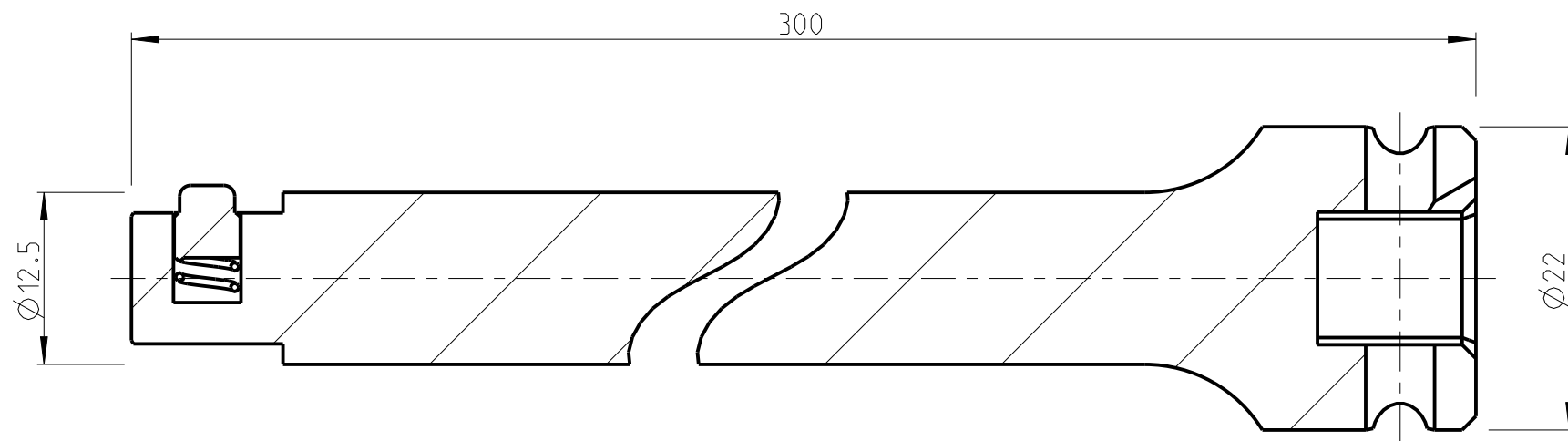
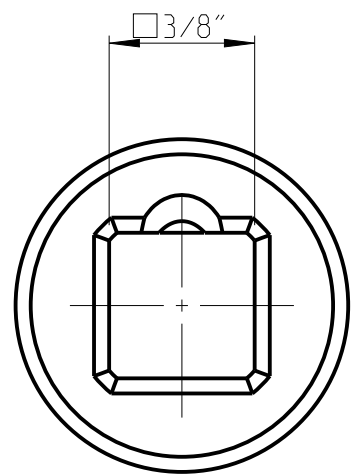

1:1

proprietary document. Not to be used in any way without our consent.

**SALTUS**

Name  
Extension-SQ3/8"-L300-SQ3/8"-P

Designation  
4027 1234 09